

PARTS AND HARDWARE

FOR A TYPICAL ASSEMBLY

ZINTRA STICKS
(10) WIDE OR (20) NARROW



CURVED RIB - (7)

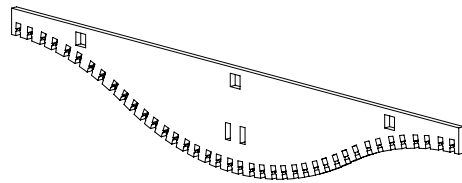

CROSSRUNNER- (3)



RIB'S SUPPORT - (7)

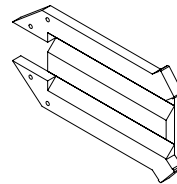

SELF DRILLING SCREW - (28)

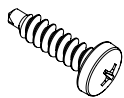

END CAP - (6)

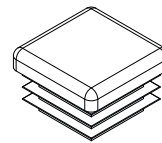

CONNECTOR - (3)

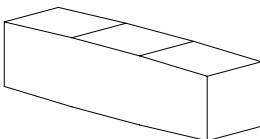

YOU WILL NEED

FOR A TYPICAL ASSEMBLY

SPIRIT LEVEL

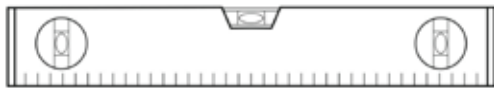

TYPE MEASURE

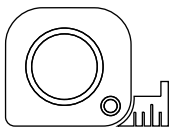

CORDLESS SCREWDRIVER (PHILLIPS BIT)

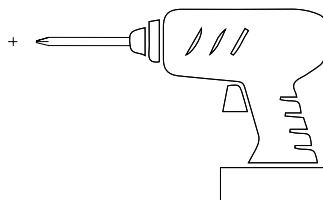

SUITABLE SCREWS FOR DIFFERENT SURFACES - (12)

SCREWS ARE NOT INCLUDED - INSTALLER TO SUPPLY BASED ON FIXING SUBSTRATE

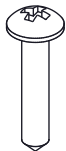

STEP 1

CURVED RIBS INTALL

- 1.1 BEGIN WITH FIRST CURVED RIB.
- 1.2 INSERT EACH OF THE CROSSRUNERS INTO THE CORRESPONDING PRE-CUT RECTANGULAR HOLES IN THE CURVED RIB.
- 1.3 WITH THE CURVED RIB ALIGNED PRESS CURVED RIB DOWN INTO NOTCH UNTIL FULLY SEATED.
- 1.4 REPEAT STEPS 1.1-1.3 FOR EACH CURVED RIB UNTIL THE ENTIRE ASSEMBLY HAS BEEN COMPLETED.

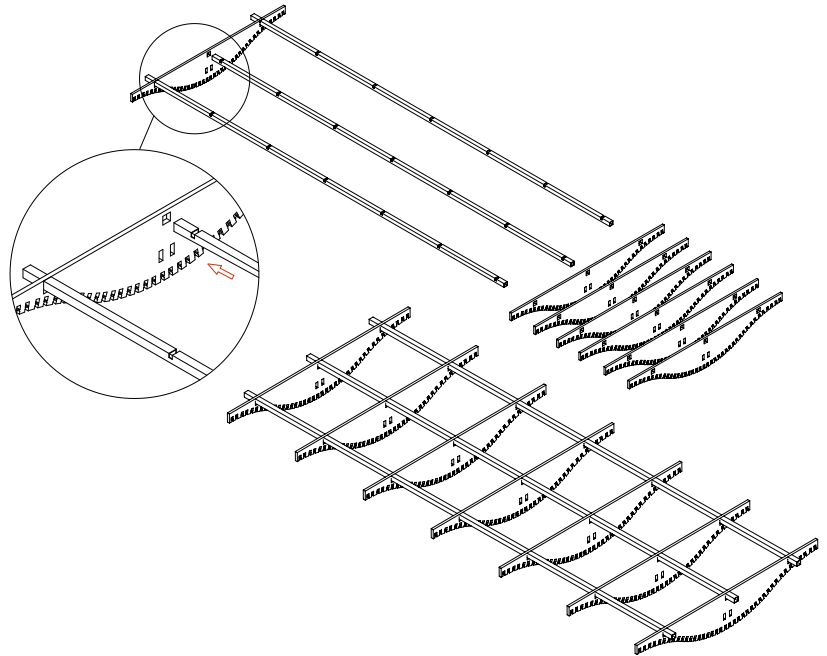

STEP 2

RIB'S SUPPORT INTALL

- 2.1 FOLD RIB'S SUPPORT.
- 2.2 INSERT THE RIB'S SUPPORT INTO THE CORRESPONDING PRE-CUT RECTANGULAR HOLES IN THE CURVED RIB.
- 2.3 WITH THE CURVED RIB ALIGNED FIX IT WITH A SELF DRILLING SCREW.
- 2.4 REPEAT STEPS 2.1-2.3 FOR EACH RIB'S SUPPORT UNTIL THE ENTIRE ASSEMBLY HAS BEEN COMPLETED.

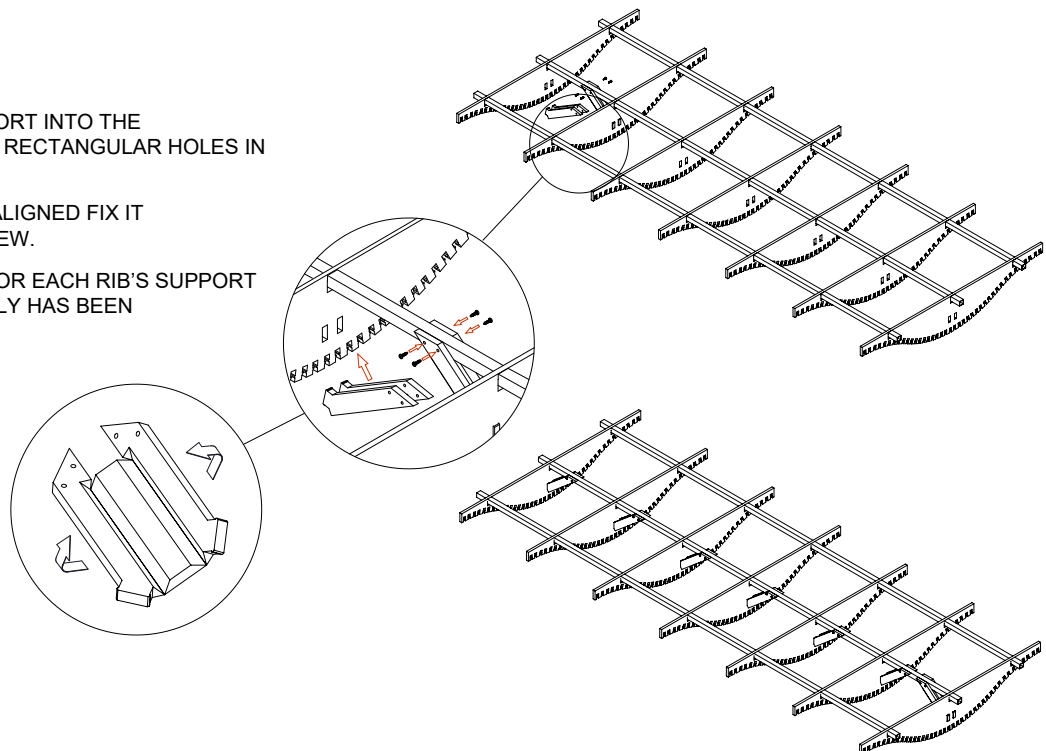

STEP 3

FRAME INSTALL

3.1 USE A LASER LEVEL OR SPIRIT LEVEL TO MARK ALUMINIUM POSITION ON THE WALL.

3.2 SECURE CROSSRUNNER TO WALL IN THE SUITABLE LOCATION FOR YOUR SITE.

3.3. FIX TO WALL WITH FASTENERS TO SUIT APPLICATION.

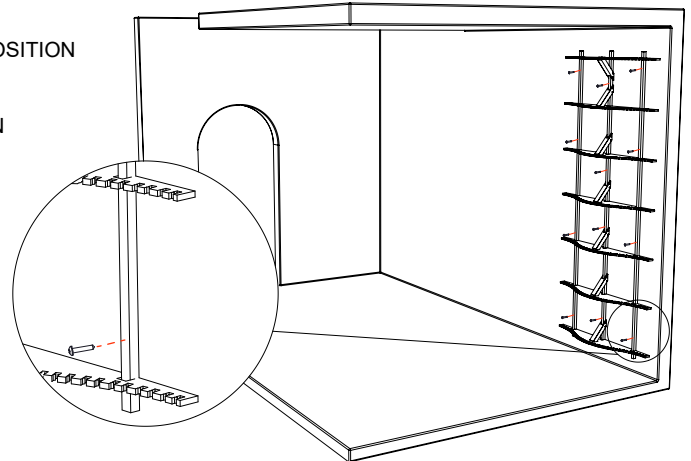

STEP 4

ZINTRA STICKS INSTALL

4.1 FOLD ZINTRA STICK.

4.2 INSERT THE ZINTRA STICK INTO THE CORRESPONDING PRE-CUT RECTANGULAR HOLES IN THE CURVED RIB.

4.3 REPEAT STEPS 4.1-4.2 FOR EACH ZINTRA STICK UNTIL THE ENTIRE ASSEMBLY HAS BEEN COMPLETED.

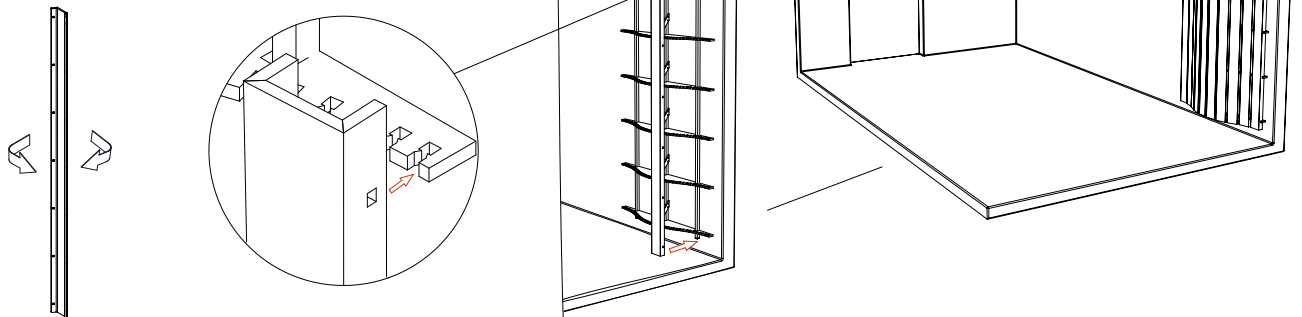

STEP 5

FINISHING INSTALL

A. CAP THE END OF THE CROSSRUNNER BY PRESSING THE SUPPLIED PVC CAPS UNTIL SECURE.

B. TO CONNECT MULTIPLE ZINTRA CURVED SYSTEMS TOGETHER USE THE SUPPLIED ZINTRA CONNECTORS. INSERT ONE OF THEM HALF WAY IN THE CROSSRUNNER, AND THE OTHER HALF INTO THE ADJACENT CROSSRUNNER. ADJUST AS NEEDED FOR ALIGNMENT.

